xDSL Tester

User Manual

V1.1

Contents

1. Summary	1
2. Main functions and specifications	2
2.1 xDSL specifications	3
2.2 Dialing test functions	4
2.3 Modem parameters setting	5
2.4 Modem emulation	5
2.5 Data storage and browse	5
2.6 DMM test	5
2.7 Cable tracing(optional function).....	6
2.8 PING test	6
2.9 Telephone call.....	6
2.10 System parameters setting.....	6
2.11 Dimension & Weight	7
2.12 Operation environment.....	7
3. Structure & Appearance	8
4. Precautions	10
5. Operation introduction.....	10
5.1 Turn on the tester	10
5.2 Turn off the tester.....	11
5.3 Adjust LCD contrast.....	11
5.4 Backlight function	11
5.5 Initiate modem	12
5.6 System setting	12

5.6.1 xDSL mode setting	13
5.6.2 PPP setting	14
5.6.3 Qos setting.....	16
5.6.4 Language setting	17
5.6.5 Regular setting.....	17
5.6.6 Auto off time length set.....	19
5.6.7 Restore setting.....	20
5.6.8 Ping mode.....	21
5.6.9 Data upload	21
5.7 xDSL test	22
5.7.1 Physical layer parameter test.....	24
5.7.2 Save test records.....	27
5.7.3 Display bit chart	27
5.8 Dial test.....	28
5.8.1 PPP dial	29
5.8.2 WAN ping.....	31
5.9 Browse records (View data)	33
5.10 DMM test	35
5.10.1 DC voltage test	37
5.10.2 AC voltage test	37
5.10.3 Resistance test	38
5.10.4 Capacitance test.....	39
5.10.5 Insulation test.....	39
5.10.6 Cable trace	40

5.11 Modem emulation	40
5.12 Tel dial.....	42
5.13 LAN ping test	42
5.14 Charge battery.....	44
6. Faults and solutions	45
7. xDSL test management software.....	45
7.1 Operation environment.....	45
7.2 Software function introduction	46
7.3 Records upload	48
7.4 Real-time data	48
7.5 Record browse.....	50

1. Summary

This xDSL Tester is specially designed to meet the urgent requirement of xDSL testing, including ADSL, ADSL2, ADSL2+, READSL and VDSL as well; It is particularly used by the field operator for the telecommunication installation and maintenance.

With the rapid development of xDSL broadband service, the field operators of installation and maintenance have to face much more and complicated workload than ever before, as a result, the equipment which is simple, portable and money-saved is eagerly wanted.

At present, most of the xDSL testers in the market are so complicated which require the operators to occupy rich signal emulation knowledge and network analysis ability. Additionally the prices are generally high. The ISP could only afford a few sets and turn help to the professional network analysis engineer to operate. In fact they are not the suitable equipments for the installation and maintenance operator.

xDSL Tester could not only test the physical parameters but also help to judge whether the line is fit for xDSL service and evaluate the quality of service. In fact the field operators do not need to know so many line parameters and specifications. To them, the most important is to determine the quality of service and locate the fault points. With the help of this tester every forefront workman is prepared to the task. Further more, it could also make PPPoE/PPPoA dialing through the built-in Modem and validate the connection between the user and ISP through emulating the user PC + Modem.

This tester adopts LCD display and menu operation. It could display the test results directly and intuitively. It is the ideal tool for the field technician installing and maintaining xDSL service.

2. Main functions and specifications

Function frame as following:

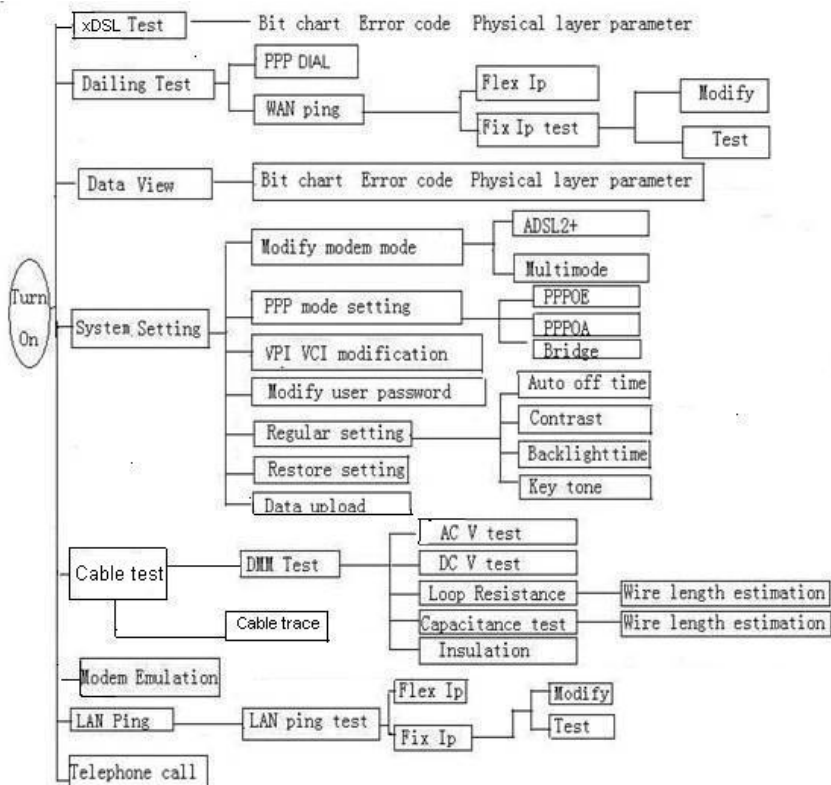

2.1 xDSL specifications

ADSL2+

- 1) Standards: ITU G.992.1 (G.dmt), ITU G.992.2 (G.lite), ITU G.992.3 (ADSL2), ITU G.994.1 (G.hs), ANSI T1.413 issue #2, ITU G.992.5 (ADSL2+) Annex L, Annex M. working mode set to be full-automatic mode.
- 2) Maximal connecting distance is 6.5km; Compatible with ADSL, ADSL2 and READSL
- 3) DSL transmission parameters:
 - DSL up/down max speed;
 - DSL up channel speed: 0 ~ 2.5Mbps;
 - DSL down channel speed: 0 ~ 24Mbps;
 - DSL up/down attenuation: 0 ~ 63.5dB;
 - DSL up/down noise margin: 0 ~ 32dB;
 - DSL up/down output power: 0~25dBm
 - Error test for LCD, OCD, HEC;
 - Test INP (Impulse Noise Protection) 0-8 ;
 - Test interlaced code: Delay, Depth;
 - Display good DSL connection mode;
 - Judge service quality, 4 grades; Excellent, Good, OK, Poor
 - Display the channel bit chart;
 - Display SNR Channel Map
 - Display channel Hlog and QLN map
 - Channel mode support fast channel and interlaced channel.

ADSL module

- 1) Standards: ITU G.992.1 (G.dmt), ITU G.992.2 (G.lite), ITU G.994.1 (G.hs), ANSI T1.413 Issue # 2
- 2) DSL transmission parameters:
 - DSL up/down max speed;
 - DSL up channel speed: 0 ~ 1Mbps;
 - DSL down channel speed: 0 ~ 8Mbps;
 - DSL up/down attenuation: 0 ~ 63.5dB;
 - DSL up/down noise margin: 0 ~ 32dB;

- DSL up/down output power: 0~25dBm
- Error test for LCD, OCD, HEC, FEC, CRC;
- Test INP (Impulse Noise Protection)0-8 ;
- Display good DSL connection mode;
- Judge service quality, 4 grades: Excellent, Good, OK, Poor
- Display the channel bit chart;
- Channel mode support fast channel and interlaced channel.

VDSL2 module

- 1) Standard: ITU G.993.2 (VDSL2) . Be compatible with ADSL2+, ADSL standard.
- 2) DSL line transmission parameter
 - DSL line attenuation
 - DSL line noise margin
 - DSL line up channel speed (Inter/Fast mode)
 - DSL line down channel speed (Inter/Fast rate)
 - DSL line up/down maximum rate and capacity ratio
 - DMT sub channel bit number: 0~15, and each sub channel frequency points
 - DSL line error number (CRC, HEC, FEC, LCD, OCD)
 - DSL line local output power
 - State display: signal loss, connection close.
 - Error Code Second
 - Impulse Noise Protection (INP)
 - SNR Chart
 - Display channel Hlog and QLN map
- 3) Support the first 7 profiles in total 8 VDSL2 profiles: profile 8a, 8b, 8c, 8d, 12a, 12b, 17a, 30a

2.2 Dialing test functions

You can fulfill the function of Perform PPP dialing to user

twisted-pair (WAN port). After successful dialing, it could get this terminal IP, opposite terminal IP, chiefly DNS server IP and subordinate IP address. The dial function includes PPPoE, PPPoA and Bridge; the PPPoE is popular in China.

2.3 Modem parameters setting

Operator can set current modem standard and choose other mode or Annex M mode. What is more, the operators can also revise PPPoE attribute (VPI/VCI), encapsulation, user name and password by management software or by buttons on the tester.

2.4 Modem emulation

This tester can replace the user Modem completely. And the user could take this tester as modem to dial and login to Internet to test if there is any problem of subscriber's Modem.

2.5 Data storage and browse

This tester has memory capacity of 50 records. The records include line parameters, channel bit chart and error test. User could browse the records on the screen through entering different record number.

2.6 DMM test

This tester can test such items as follows:

- 1) AC Voltage: -400 to 400 V; Resolution: 0.1V
- 2) DC Voltage: 0 to 290 V;
- 3) Capacitance: 0 to 1000nF
Accuracy: 0—10nF: $\pm 2\text{nF}$; 10nF-1000nF: $\pm 2\% \pm 2\text{nF}$
- 4) Loop Resistance: 0 to 20K Ω ;
Accuracy: 0-100: $\pm 3\% \pm 4\Omega$, 100—500: $\pm 3\%$, 500—20 K Ω :

±2%

5) Insulation Resistance: 0 to 50MΩ;

Accuracy: 0—1.0M: ±0.1 MΩ, 1.0—30M: ±10%±0.5 MΩ

2.7 Cable tracing (Optional function)

With supplied accessory, it can do cable tracing and find the trend of the lines.

2.8 PING test

It can perform the WAN PING Test and LAN PING Test. LAN PING Test can judge if the connection with IP addresses success or not and also confirm LAN work OK or not. WAN PING test can Ping website addresses directly toward Local WAN, and check the connectivity of WAN Line.

2.9 Telephone call

Same function as a simple telephone: dial and answer. You can pick up the phone when you are testing data.

2.10 System parameters setting

Users can set the lighting length of backlight. The default time is 15s, and the utmost time is 99S. The default Auto-off time is 8 minutes; users can set the time length from 5—59 minutes. The key-press sound can be set need, or not need, and the buttons can modify the username and password, VPI, VCI, adjust contrast and Modem working mode modification and PPPoA, PPPoE, Bridge dial mode, restore the original setting, data upload etc.

2.11 Dimension & Weight

Dimension (mm): 180 × 93 × 48

Weight: < 500g

2.12 Operation environment

- a) Temperature: 0 °C ~ +50 °C
- b) Humidity: ≤ 85%
- c) Pressure: 86kPa ~ 106kPa
- d) Power supply: The rechargeable lithium batteries
2000mAH, DC8.4V charger
- e) Battery duration: > 3.5 hours

3. Structure & Appearance

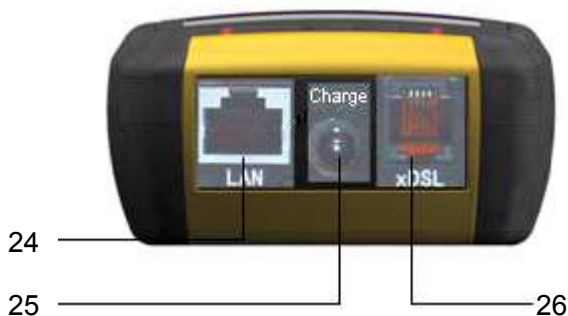

1. HOOK LED
2. Ethernet LED
3. PPP LED
4. LCD
5. Enter button
6. Number button: 1
7. Left button and Number button: 4 and Character: ghi
8. Number button: 7 and Character: pqrs
9. Character: * and Special Character enter button.
10. Power on button
11. Power off button
12. Number button: 0
13. Character : #
14. Number button: 9 and Character: wxyz
15. Down button and Number button: 8 and Character: tuv
16. Number button: 5 and Character: jkl and backlight
17. Right button and Number button: 6 and Character: mno
18. Number button: 3 and Character: def
19. Cancel button
20. Up button and Number button: 2 and Character: abc
21. Link LED
22. Power LED
23. POTS LED
24. RJ45 port for Ethernet.
25. Charge port for charger.
26. RJ11 port for test line.

LED introduction

ETH LED: Shinning - Ethernet link in normal condition.
Flicker - There is data flux in Ethernet.

Link LED: LED flicker slowly - finding central office,
LED flicker rapidly - xDSL Modem is doing the xDSL handing;
Shinning - Link connected and work normally.

PPP LED: Shinning - successful PPPoE dialing or PPPoA dialing;

POTS LED: Green: POTS voltage OK. Orange: POTS voltage high. No light: No voltage or voltage too low.

4. Precautions

- For the first time use, please make sure that the battery is fully charged before initiating machine. (refer to 5.14 item)
- If there is any abnormal phenomenon during operation, please restart the instrument.
- To ensure the normal operation, please press the operation buttons for 0.5 second until you hear the tone.
- The test result will be affected if the user terminal is in use when testing. Please disconnect the user terminal before make a test.
- Please confirm username, password, VPI/VCI and PAP/CHAP before making PPP dialing.
- If there is ▲ or ▼ on screen, please operate as it indicates.

5. Operation introduction

5.1 Turn on the tester

Pressing “ON” button for 1 second, the power LED will shine. After hearing “Di...” sound, the LCD will display the main menu that means the tester has been started, the Pic.5.1-1 as follows:

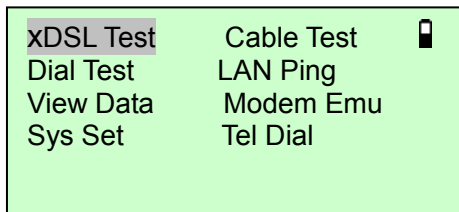

Pic.5.1-1

5.2 Turn off the tester

- When this tester is in normal working mode, press “OFF” button to turn off the tester step by step.
- Press “OFF” button last a long time about 4~5 seconds, you also can switch of the tester obliged.
- When the battery is in low voltage, it will power off automatically.
- If there is no any operation of the tester for 8 minutes, this tester will power off automatically.

5.3 Adjust LCD contrast

When the tester is “ON”, users can enter into “Sys set” interface, then enter “Regular setting”, through the “Up” button and “Down” button adjust the contrast of LCD.

5.4 Backlight function

During the operation, the operator can press “Backlight” button to turn on or turn off the backlight. In normal condition if there is no any operation on keyboard after 15 seconds, the tester will shut off automatically.

5.5 Initiate modem

After power on, the tester will enter into the main menu, see Pic.5.5-1 as follows. Press “OK” to perform xDSL Test. Firstly, the tester will initialize the Modem. If the modem initialization fails, the system will make the Modem reposition, if also failed, the tester will back to the main menu.

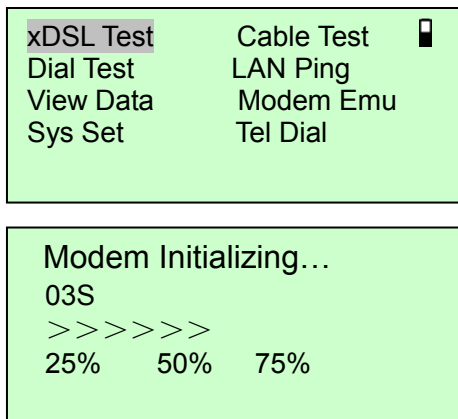

Pic.5.5-1

5.6 System setting

In main menu, please move the cursor to the **Sys Set** (system setting in Pic.5.6-1) item by pressing ▲, ▼, ◀, ▶ according to indication. And press the “OK” button to display Modem setting parameters. (Pic.5.6-2)

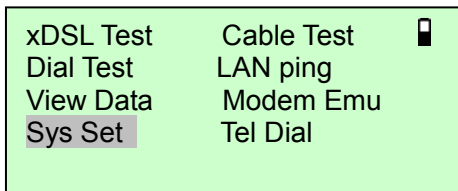

Pic.5.6-1

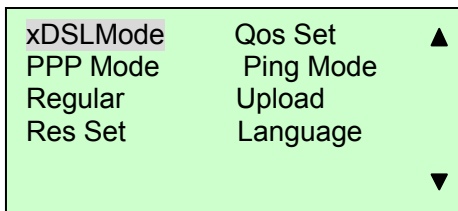

Pic.5.6-2

5.6.1 xDSL mode setting

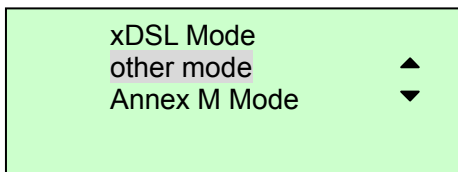

Pic.5.6.1-1

Under Pic.5.6-2, move the cursor to **other Mode**, press OK to come into the xDSL mode interface.

If it is the first time to enter xDSL mode set window, the selected item is current xDSL mode setting as Pic. 5.6.1-1 shows.

Other means: G.Dmt, G.lite, T1.413, ADSL2, Annex L, ADSL2+, VDSL2.

Annex M: support ADSL2+'s appendix M, meet down rate 24Mbps, up rate 3.5 Mbps. Press OK key, you set

current reverse mode, there is a tip after successful setting.

In the Pic.5.6.1-1, according to the indication, you can move the cursor to the item you want to set pressing ▲ or ▼. Press “OK” button, then the setting information will be displayed on the screen.

If the mode is revised, press “OK” button, and the tester will display the follows.

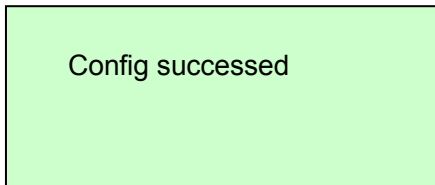

Pic.5.6.1-2

At this time, the xDSL Modem built in the tester will connect according to you new set standards.

5.6.2 PPP setting

In the following Pic.5.6.2-1, move the cursor to PPP mode; press OK to enter into the modification interface. The length username is 1-49, the length of password is 0-49.

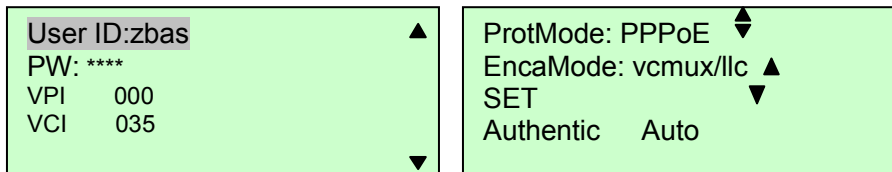

Pic.5.6.2-1

A. Input method switch

The # key is the key to switch input method, press this key, "↻,123, abc, ABC, and delete" icon circle shows

The upper right corner:

- ↔ : Cursor can be moved, only the direction buttons work.
 123 : Enter numbers only;
 abc : Enter lowercase character only.
 ABC: Enter uppercase character only.
 Delete: Press “Cancel ”button to delete the character, press direction buttons to move the cursor.

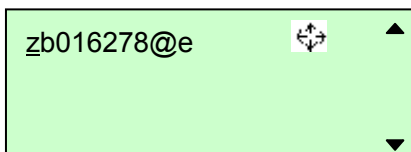

Pic.5.6.2-2

B. Enter special characters

Press button *

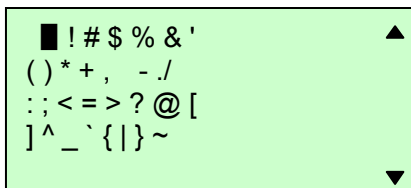

Pic.5.6.2-3

Based on Pic.5.6.2-3, press direction buttons to choose the character then press “OK” button to enter this character ; press “Cancel” button to give up the enter.

C. Exit the modifications of characters

After modify, press # button to switch the input method to the undelete mode. Press “Cancel” button to quite the character input.

Input the password:

Under Pic.5.6.2-1, move the cursor to “Password”, press OK button to enter the password, same method as the username modification.

Auth Mode:

Choose the “PAP” or “CHAP” by moving the cursor.

PAP (Password Authentication Protocol)

CHAP (Challenge Handshake Authentication Protocol)

Save the modification:

After all the modification completed, move the cursor to the setting under Pic. 5.6.2-1, then press OK button, the tester will display “changing...please wait”. When the notification vanishes, the final setting will be completed.

5.6.3 Qos setting

Standard thresholds setting, the quality of service is judged by below 4 parameters.

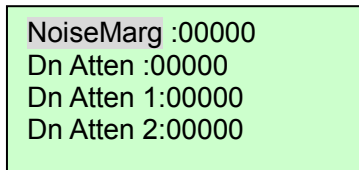

Pic.5.6.3-1

Reverse **Qos Set** in the Pic.5.6-2, and press OK enter this interface.

Real Noise Margin (Down) < Noise Margin of Threshold, the service is poor

Real Noise Margin (Down) > Noise Margin of Threshold, operators should judge the attenuation.

Reference standard:

- Real Down Attenuation < Down Attenuation of Threshold, service quality: Excellent
- Real Down Attenuation < Down Attenuation of Threshold 1, service quality: Good
- Real Down Attenuation < Down Attenuation of Threshold 2, service quality: OK
- Real Down Attenuation > Down Attenuation of

Threshold 2, service quality: Poor

Reference standard:

Noise Margin Threshold	Down attenuation Threshold	Down Attenuation Threshold 1	Down Attenuation Threshold 2
6.0	35.5	48.5	62.5

5.6.4 Language setting

Reverse **Language**, press OK, enter language setting interface.

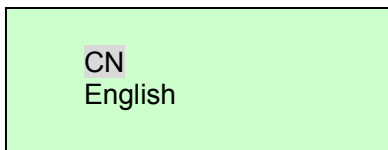

Pic.5.6.4-1

Operators can choose ‘Chinese’ or ‘English’. Press ok, enter to modify the current highlighted contents. Press cancel to exit the the modified interface. Please note that different versions have different interfaces.

5.6.5 Regular setting

In the Sys Setup menu (Pic.5.6-2), move the cursor to “Regular”, then press “Enter” button to enter into the regular setting interface.

Auto Off	08m
Bklt Time	15S
Key Tone	Open
Contrast	20

Pic.5.6.5-1

Backlight time set:

The default time of backlight is 15S. If users want to change the time, they can change it in this interface. The utmost length is 99s.

In the Pic.5.6.5-1, press “Enter”, users can change the time length by “Up” or “Down”, The number will moves from 5~99:

Auto Off	08m
Bklt Time	15S
Key Tone	Open
Contrast	20

Pic.5.6.5-2

Press “Enter”, the backlight time will be set.

Key Tone set: Move the cursor into “Key Tone” by “Down” button, Pic.5.6.5-3 as follows:

Auto Off	08m
Bklt time	15S
Key Tone	Open
Contrast	20

Pic.5.6.5-3

Turn off the Key Tone:

In the Pic.5.6.5-3, press “Up” or “Down”, the “ON” will

change into “OFF”, Pic. as follows:

Auto Off	08m
Bklt time	15S
Key Tone	Shut
Contrast	20

Pic.5.6.5-4

Adjust the contrast:

In the Pic.5.6.5-4, press “Up” or “Down”, the cursor will move to “Contrast”, Pic. as follows:

Auto Off	08m
Bklt time	15S
Key Tone	Shut
Contrast	20

Pic.5.6.5-5

Press “Enter”, change the number “20” by “Up” or “Down”, Pic. as follows:

Auto Off	8m
Bklt time	15S
Key Tone	Shut
Contrast	21

Pic. 5.6.5-6

Press “Back”, users can back to the upper menu.

5.6.6 Auto off time length set

In the Pic.5.6.5-5, move the cursor to “Auto off” by button,

Pic. as follows:

Auto Off	08m
Bklt Time	15S
Key Tone	Shut
Contrast	20

Pic.5.6.6-1

In the Pic.5.6.6-1, press “OK”, users can change the time by “Up” and “Down”

Auto Off	09m
Bklt Time	15S
Key Tone	Shut
Contrast	20

Pic.5.6.6-2

Press “Back”, users can back to the upper menu.

5.6.7 Restore setting

In the Sys Setup menu (Pic.5.6-2), press “Up”, “Down” to move the cursor to “Res Set”, then press “OK”, there will be “Are you sure to restore factory setting?” press “OK”, then the LCD will display manufacturing default settings as shown in Pic.5.6.7-1

Auto Off	08m
Bklt time	15S
Key Tone	on
Contrast	43

Pic.5.6.7-1

⚠ Notice: All the parameters in Modem restore to the factory original setting.

5.6.8 Ping mode

In Pic.5.6-2, move the cursor to “Ping Mode”, press OK, “Ping Mode” setting is as Pic.5.6.8-1:

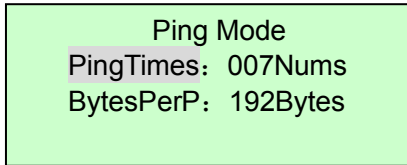

Pic.5.6.8-1

To modify the Ping frequency and Ping packet by press the buttons.

5.6.9 Data upload

Data line connection as following:

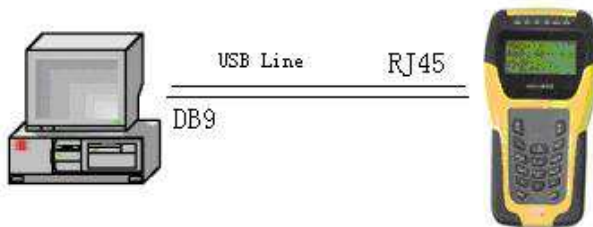

Pic.5.6.9-1

Now connect the RJ45 point on the “data line” to the LAN port, another point connect to the computer.

In the sys set menu, move the cursor to the **Upload** by “Up”, “Down”, “Left” and “Right” button, as below Pic.shows:

xDSLMode	Regular
UserName	Res Set
PVCn	Ping Mode
PPP Mode	Upload

Pic.5.6.9-2

Then press “OK” button, tester will display “Waiting for handshaking signal”. as below Pic. Shows:

Waiting for
handshaking signal

Pic.5.6.9-3

Open management software, switch to upload interface, click “receive data” button, then the tester will quickly display “Uploading the XX data”, as shown in Pic.5.6.9-4

Uploading the XX data
Handshaking succeed

Pic.5.6.9-4

After successful data uploading, through management software can do the data analysis, static display each set of data.

5.7 xDSL test

xDSL test also called physical layer test, for testing the physical parameters of xDSL lines, including the current state, link mode, up / down rate, the max rate, noise margin, the power attenuation, power output, CRC error, HEC error,

FEC error, LOS error, NCD error and channel bit chart. The details refer to the following picture.

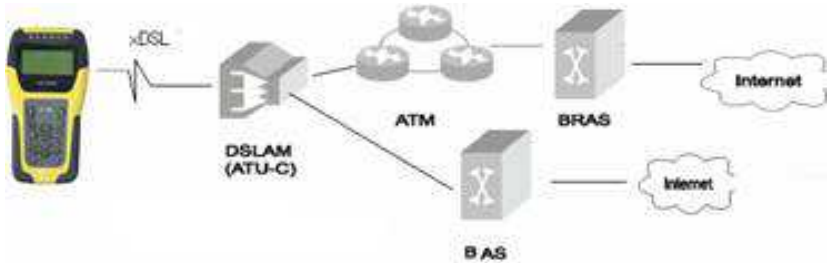

Pic.5.7-1

Press ▲ or ▼ to move the cursor to the **xDSL Test** option and press **OK** button to enter the xDSL test window as shown in Pic.5.7-3

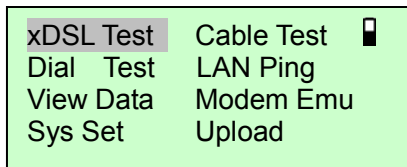

Pic.5.7-2

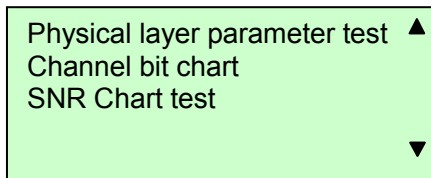
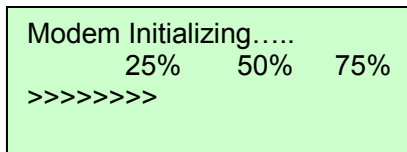

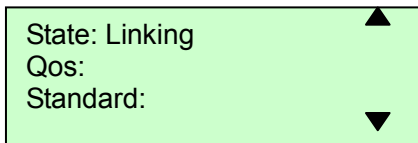

Pic.5.7-3

In this interface, press the “Cancel” button, you can withdraw from the xDSL test and return to the main menu (Pic5.7-2). Tester entered the initial stage of Modem, then entered second initialization times, if initialization still failed, LCD display “initialization Modem failed, enter the menu?” you can return to the main menu interface by pressing “conform” or “Cancel” button, as shown in Pic5.7-3. If the initialization Modem has repeatedly failed to initialize, please contact your dealer for after-sale maintenance, to ensure the normal using.

5.7.1 Physical layer parameter test

In xDSL test window you could browse many parameters by pressing ▲ or ▼ according to the indication. The parameters include current state (State), Quality of Service (QoS), Link mode, up/down stream rate (Up/Dn rate), up/down max rate, up/down attenuation(Up/Dn Atten), up/down noise margin(NoiseMar) and up/down output power(Output $P_{U/D}$). Please refer to Pic.5.7.1-1.

The parameters are divided into 2 groups. Bars on left show the parameters before synchronization while bars on right the parameters after synchronization.

Fitful LNK LED shining - Modem is not in synchronization and current state is “connecting”.

Steady LNK LED shining - Modem is synchronizing and current state is “connected”.

Before Modem synchronization

After Modem synchronization

State: Linking ▲
 QoS : ▼
 Standard:ADSL2+ Auto ▼

State: Connected ▲
 QoS: OK ▼
 Link Mode: G .dmt ▼

InterRateU: 0 kbps ▲
 FastRateU: 0 kbps ▼
 InterRateD: 0 kbps ▼
 FastRateD: 0 kbps ▼

InterRateU:512 kbps ▲
 FastRateU: 0 kbps ▼
 InterRateD: 2048 kbps ▼
 FastRateD: 0 kbps ▼

Max RateU: 0 kbps ▲
 Max Rate D: 0 kbps ▼
 Up Atten: 0 dB ▼
 Dn Atten : 0 dB ▼

MaxRateU: 912 kbps ▲
 MaxRate D: 8308 kbps ▼
 Up Atten: 512 dB ▼
 Dn Atten : 2048 dB ▼

NoiseMarU: 0.0 dB ▲
 NoiseMar D: 0.0 dB ▼
 Output PU: 0.0 dBm ▼
 Output P D: 0.0 dBm ▼

NoiseMarU: 15.0 dB ▲
 NoiseMarD: 27.5 dB ▼
 Output PU: 12.3 dBm ▼
 Output P D: 19.4dBm ▼

INP_U: ▲
 INP_D: ▼
 HEC_U: ▼
 HEC_D: ▼

INP_U: 0 ▲
 INP_D: 0 ▼
 HEC_U: 0 ▼
 HEC_D: 0 ▼

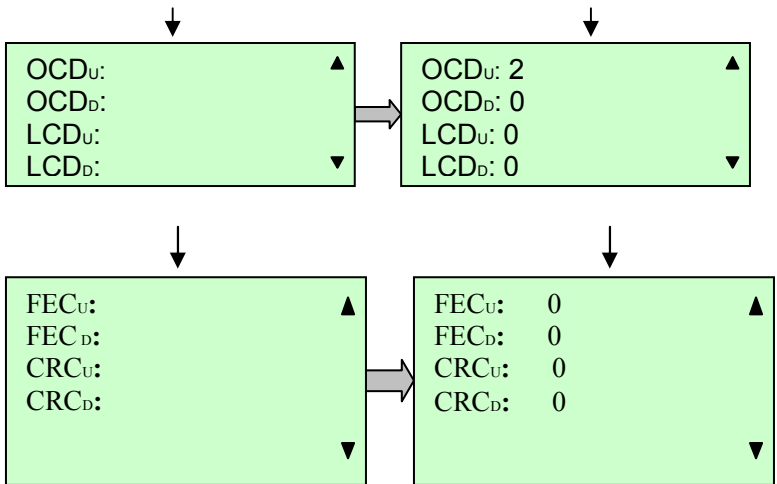

Pic.5.7.1-1

Link mode:**ADI:** ADI mode of ADSL;**G.dmt:** ADSL G.DMT mode, ITU-T G992.1 standard compliance;**G.lite:** ADSL G.LITE mode, ITU-T G992.2 standard compliance;**T1.413:** ADSL T1.413 mode, ANSI T1.413 issue1 & Issue 2 standard compliance.**G.dmt.bis:** ADSL2 G.DMT.BIT mode, ITU-T G992.3 standard compliance;**G.dmt.bisplus:** ADSL2+ G.DMT.BISPLUS mode, ITU-T G992.5 standard compliance.**ADSL2/2+:** ADSL2+G.dmt.bisplus mode, ITU-T G992.5 compliance.**Service quality:** ADSL2+ Tester has 4 levels to show the service quality, that is, to show whether the line is fit for xDSL service and evaluate current service quality. They are:

Excellent, Good, OK and Poor .**5.7.2 Save test records**

In Pic.5.7-3, please click “Esc” button to return main menu if Modem is not in synchronization. If the modem has been in synchronization and tester will display following content.

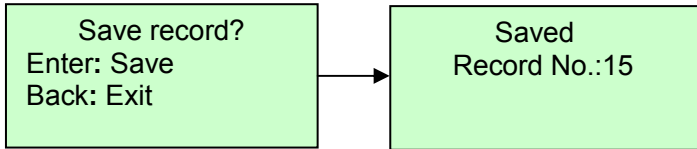

Pic.5.7.2-1

Press “Esc” button to refuse to save record and return main menu; while press “OK” button to save record and its record number will be displayed as the right bar shows (Pic.5.7.2-1).

Additionally this tester has a memory capacity of 50 records. Once a record is saved, the record No. will increase by one automatically. When the user tries to save 51th record into the tester, the first record will be overlapped.

The saved contents include line transmission parameters and channel bit chart as well as error code.

Operators can view saved records through “View Data” (Refer to 5.9 View Data function)

5.7.3 Display bit chart

In the window of Pic.5.7.1-1, press ▼ button, if the modem isn’t synchronized, then there will not be any graph.

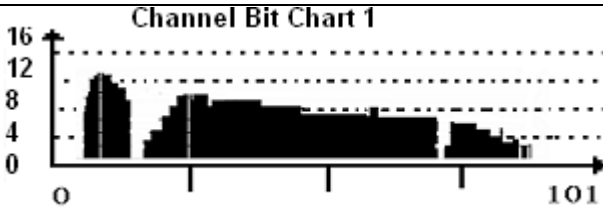

Pic.5.7.3-1

Press ▼ Button, the bit chart with first 102 channels will be displayed, and then next until all 512 channels are displayed; press “Back” button to return to the main menu. The number of channel bit chart will be different due to the difference of user line. Usually there are 512 or 256 channels. There will be 4096 channels when in the VDSL mode connection.

5.8 Dial test

Function introduction: PPP (Point-to-Point Protocol) designing, is aimed to establish Point-to-Point data-transport by dialing or special line. It has become a common solution scheme between the host, bridge and router. PPP link process: Stage 1: Creating a PPP link; Stage 2: user authentication; stage3: Recall network layer protocol. Using Ethernet (Ethernet) resources, carrying out PPP protocol on Ethernet to test a user authentication method, called PPPoE. PPPoE is to protect the user's Ethernet resources, and achieve the requirements for ADSL link; it is the most extensive technical standards in application xDSL.

Uniformity, running PPP protocol on the ATM (Asynchronous Transfer Mode) to manage user authentication, called PPPoA, it is as the same as PPPoE in principle and function, but difference is that PPPoA run on ATM internet, the PPPoE work on Ethernet, so it should be

suit for ATM stander and Ethernet. Physical linking refers to the following Picture.

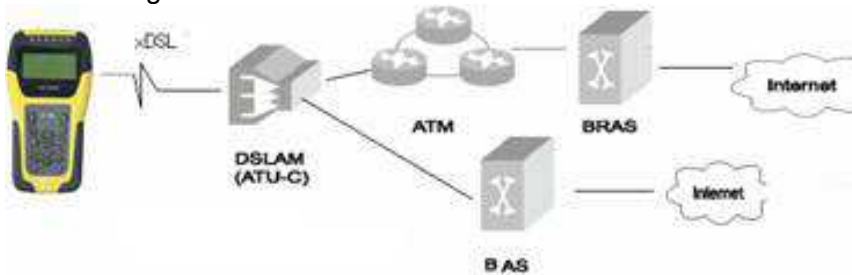

Pic.5.8-1

In main menu , press ▲ or ▼ to select **Dial Test** option.

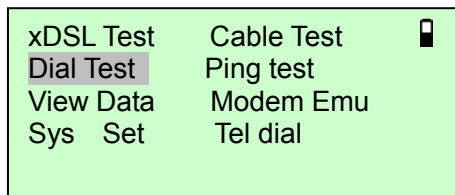

Pic.5.8-2

Press “OK” button and Pic.5.8-3 will appears:.

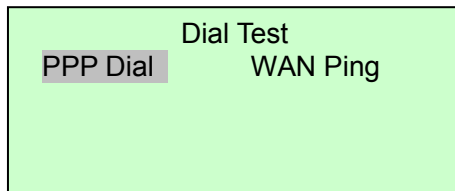

Pic.5.8-3

5.8.1 PPP dial

Press “OK” button in Pic.5.8-3 to do PPP Dial; operators can choose dial mode in Sys Set.

PPP Link LED Bright means the dial success. The PPPoE or PPPoA dialing information as Pic.5.8.1-1

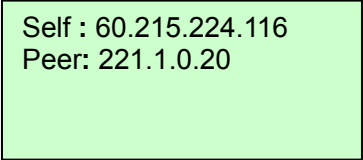

```
Self : 60.215.224.116
Peer: 221.1.0.20
```

Pic.5.8.1-2 PPPoA or PPPoE Mode

Now if the Modem Sync succeeded, the operator can do PPP dial; if the Modem doesn't sync, operator should wait until the Sync succeed and PPP dial will carry out automatically.

Press "Esc" when operator wants to exit from the testing, the LCD will show "Restoring....". And it will return to Pic.5.8-2 in about 8s.

Dial parameters introduction and Modification:

There are 7 groups VPI/VCI parameters. Operators can modify them through management software (Refer to software manual), and also can modify them through the keys of the tester.

The tester has only one fixed PPP test account.

Operator can read or change it through management software (Only can read user name). Operator can also read or change the PPP auth Mode to choose PAP/CHAP Auth Mode. Before test, please confirm the fixed test account and auth mode are correct. Operator can change user name, password and auth mode through keys also.

Among the 7 groups VPI/VCI parameters, only when the testing line's VPI/VCI match 1 of the 7, the user name, the password and auth Mode are all correct, PPP dial will carry out automatically. Display "Failed to authenticate, please test turn off and test later " When dialing , because the xDSL line break improperly, and the LAN end hang up

the line in a short time. It will be ok according to the operating instruction.

VPI (Virtual Path Identifier)

VCI (Virtual Channel Identifier)

Self: Self IP Address

Peer: Remote IP Address

5.8.2 WAN ping

Linking frame refers to the following picture:

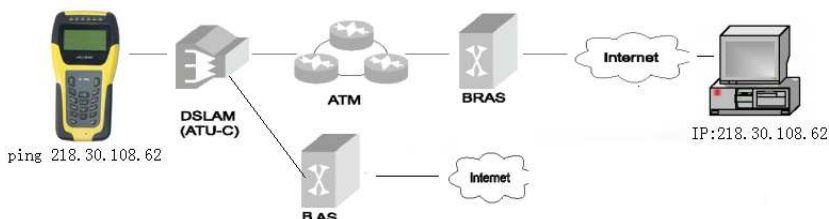

Pic.5.8.2-1

Move the cursor to “WAN Ping”, Press “OK”, the following Pic. will be displayed.

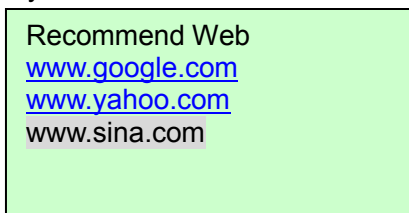

Pic.5.8.2-2

Move the cursor to the third item, the screen will display “Edit” “Test”

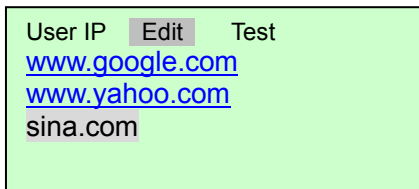

Pic.5.8.2-3

Move the cursor to “Test” by button

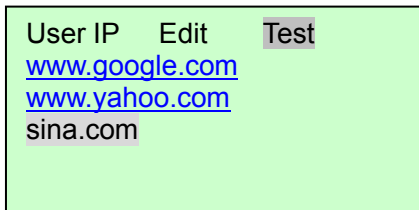

Pic.5.8.2-4

Modify the web:

In the above Pic.5.8.2-3, press “OK” to enter into the characters modification interface. The modify method is the same as 5.6.2: User Name and password modification.

WAN ping:

In the above Pic., “Testing, please wait” will be displayed in the screen, after about 8s the test result will comes out as follows:

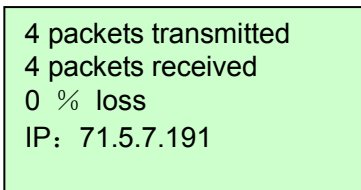

Pic.5.8.2-5

The above picture shows content:

4 packets transmitted	send 4 data packet
4 packets received	receive 4 response data packet
0 % loss	lost number is 0%
IP: 71.5.7.191	ping destination port IP address

If the Dial is failure, when perform Ping Test, there will be “Please make sure PPP Dial succeeds, or the web is correct, and then do Ping Test”.

Sometimes the PPP Dial succeeds, but the screen display “Test failure, please retest”. This is caused by the serial port data unstable; users can operate the tester according to the note.

5.9 Browse records (View data)

In main menu, move cursor to the **View Data** option by pressing ▲ or ▼, please refer to following Pic.:

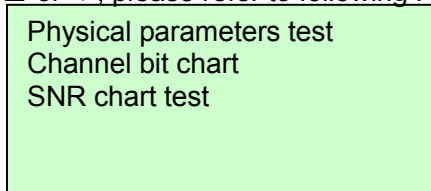

Pic.5.9-1

Press “OK” button and the LCD will display the picture as follows.

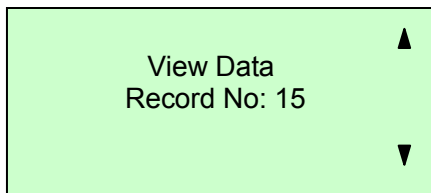

Pic.5.9-2

Now the selected record No. is the newest record number.

If you want to read record please press “OK” button. In the record you could view current state, service quality, connection mode, up/down streams rate, up/down max rate, up/down attenuation, up/down noise margin and up/down output power and error test by pressing ▲ or ▼ (Pic.5.9-3)

In Pic.5.9-2 window, the user could select the other record number by pressing ▲ or ▼. After that, please press “OK” button to browse the selected record.

State:	Showtime	▲
Qos:	Excelent	
Link mode:	G.dmt	▼



InterRate _U :	512	kbps	▲
FastRate _U :		kbps	
InterRate _D :	2048	kbps	
FastRate _D :		kbps	▼



Max Rate _U :	912	kbps	▲
Max Rate _D :	8308	kbps	
Up Atten:	13.5	dB	
Dn Atten:	27.0	dB	▼



Noise Mar _U :	15.0	dB	▲
Noise Mar _D :	27.5	dB	
Output P _U :	12.3	dBm	
Output P _D :	19.4	dBm	▼



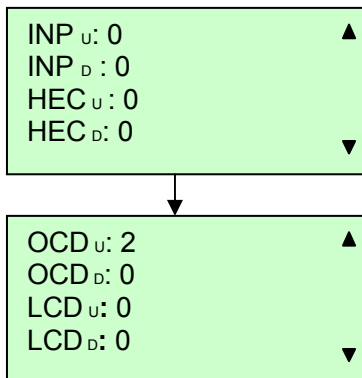

Pic.5.9-3

Please press “Back” button to stop browsing and return the main menu.

5.10 DMM test

Built-in digital multimeter can test the DC and AC voltage, resistance, capacitance, insulation resistance parameters. Maintenance personnel can use these functions to test if there is danger voltage, or the existence of 48 V voltages on the telephone line. As the following Pictures:



Pic.5.10-1

In the main menu, move the cursor to the **Cable Test** by “Up”, “Down”, “Left” and “Right” button as Pic.5.10-2 shows:

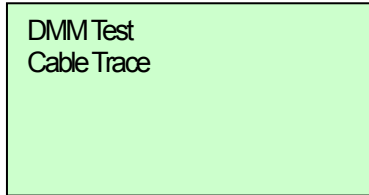

Pic.5.10-2

After click the “OK” button, the LCD will display the following Pic.

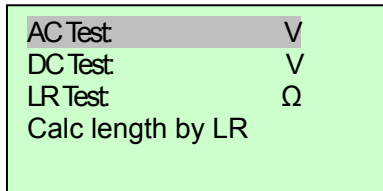

Pic.5.10-3

Now as Pic.5.10-3 shows, the AC currency is measured, and the value will be refurbished every 0.5 second, In addition to testing AC voltage, if the lines have more than two volts of alternating current on it, the tester will prompt, this means can not do the tests. You can see the next page by the movement of ▲ or ▼.

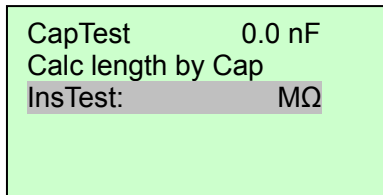

Pic.5.10-4

Then press “OK” button to begin testing insulation, the screen will display the screen shown in Pic 5.10-4. Press “OK” button to confirm data measurement. In AC voltage,

DC voltage, resistance test, it is automatic test. For other items, please press “OK” button to confirm the test.

While withdrawing from the DMM test, if the line voltage is higher than safe voltage, in order to protect circuits, tester is not allowed to withdraw from DMM test, there will be “larger than the online voltage safe voltage, can not withdraw from the DMM test” tips. Only the elimination of voltage or line voltage is less than the security voltage can be returned to the main interface. Usually, to withdraw from the DMM test is to remove the test line. “Safe voltage”: DC to 80 V, AC to 50 V, between AC50V to AC80V is a critical state, sometimes can directly withdraw from DMM test, and sometimes can not. But if the voltage is more than 80 V, can not withdraw from DMM test.

5.10.1 DC voltage test

The voltage test can test if there is a signal in the line. For ordinary telephone services bundled in the xDSL lines, if the line voltage is low or 0 V, means the line is not in use or under bad insulation, short circuit or open circuit, need to check the line.

In this test, the DC voltage range is $-400\text{ V} \sim +400\text{ V}$. When beyond the range of testing, the equipment will be prompted to “out of range”.

5.10.2 AC voltage test

AC voltage test can test the high-voltage alternating current in the line in order to protect the lineman. If encounter high-voltage alternating current please remove the test nips

carefully to avoid electric shock.

The test is limited to the AC voltage test range of 0 ~ 290 V.

The equipment will be prompted to “out of range” beyond this range.

5.10.3 Resistance test

Use resistance test function can determine the length of cable. Conversely, if you know the length of the cable, the resistance test result will show whether the cable connection is good or not.

Calculation formula:

$$L = RL / RO \text{ (Km)} \text{-----} \textcircled{1}$$

①: RL is resistance measurements result (Ω), RO is the resistance (Ω) per kilometer.

General specifications for the 0.32 mm of copper RO = 435.2 Ω , specifications for the 0.4 mm copper RO = 278.5 Ω , specifications for the 0.5 mm copper RO = 178.3 Ω .

If the course of testing equipment tips “out of range” which shows test nips not connected or cable not looped or out of resistance range, please check the test nips or retest after loop the cable again.

In the test, if there in voltage (voltage more than 2V) in the line, then there will be a prompt “voltage!”. It means this line have electricity and can not test the resistance. Please check the lines and test after cutting the electricity.

5.10.4 Capacitance test

Use of capacitance test function can determine the length of lines. If there is no bridge tap or waterish logged, we can get the length from the test result of the capacitance.

Calculation formula:

$$L = C_{ab} / C_{0} \text{ (Km). ----- } \textcircled{2}$$

②: C_{ab} for capacitance test result (nF), C_{0} capacitance result (nF) per kilometer.

Commonly use telephone cable capacitance per kilometer:
 $C_{0} = 51\text{nF}$.

If the tester prompts “out of range”, that means capacitance out of range or the cable have faults, please re-test after checking the lines.

Conducting this test, if the lines have voltage (voltage more than 2 V), the tester will prompt “voltage!”, and then return to the test menu. This means the line have electricity and can not test the capacitance, please check the line and retest after cutting the electricity.

5.10.5 Insulation test

Insulation test can test the insulation status of the line. If the insulation resistance value is small, means the insulation is bad, this will the make quality of the transmission very bad, need to repair. General for ADSL lines, insulation resistance value should be more than 10 M Ω .

In this test, if the line have voltage (voltage more than 2 V), Tester will prompt “voltage!” This means the line have

electricity and can not test the insulation, please check the line and retest after cutting the electricity. If the line resistance out of value range, the tester will show “Out of 50M Ω ”, that means the insulation is good.



Notice: When testing insulation, tester will bring a 100V's voltage, please operate it very carefully and do not touch the test nips by hand!

5.10.6 Cable trace

Applications: It is used to trace the routing path in the disorderly lines.

Method: When the tester enters into the cable trace interface, the tester will produce composite high-frequency signal sound “dudu...”. The receiver head can close to the cable with the help of the receiver end. The receiving end will amplify the received signal and broadcast audio signal. You will hear “dudu...” sound; it is louder near the clip line, the smaller the contrary. The composite high-frequency signal will turn off when exiting the tracing interface.

5.11 Modem emulation

Function Introduction: If the Ethernet can not be connected, firstly, we should test the Modem is good or not. We can use tester replace the user's Modem. As the following picture:

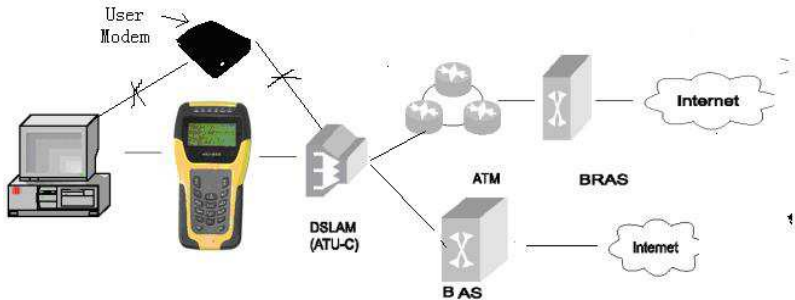

Pic.5.11-1

In the main menu (Pic.49), moves the cursor to the **Modem Emu** by “Up”, “Down”, “Left” and “Right” button as Pic.66 shows:

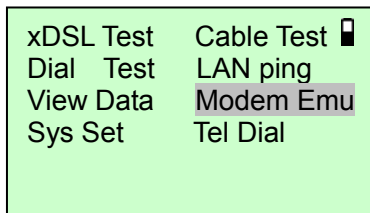

Pic.5.11-2

Then press “OK” button, tester will display “Setting...Please wait”, after 4 seconds the tester will display “In Modem emulation state”:

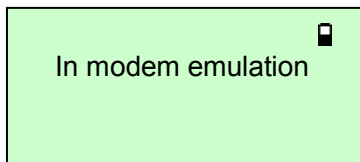

Pic.5.11-3

When this tester is in operation, it could be used as xDSL Modem. And user could make dialing or logon the Internet by this tester to see if there is any fault in user Modem.

During Modem emulation the tester works under RFC1483 Bridge mode.

5.12 Tel dial

Function Introduction: Inside it a normal telephone is integrated. The user can either answer the phone or call out during a normal ADSL test. Calling won't interrupt the test.

You can hear dialing tone when entering into the dialing interface, press the keyboard to call out. If there is a call the POTS indicator light will flicker and a “didi” sound will be heard on any other interface except the DMM test. You can answer the phone by entering into the dialing interface as Pic. shows:

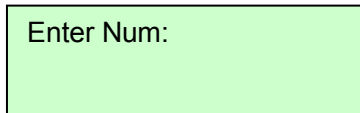

Pic 5.12-1

5.13 LAN ping test

Connection frame Pic.(5.13-1):

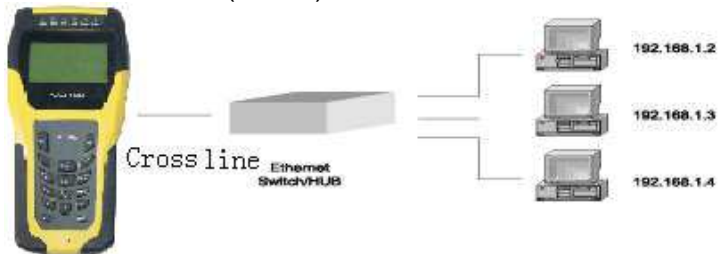

Pic.5.13-1

In the main menu, move the cursor to the **LAN Ping** by “Up”, “Down”, “Left” and “Right” button as Pic. shows:

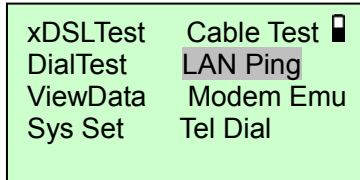

Pic.5.13-2

Then press “OK”, tester will display below Pic.:

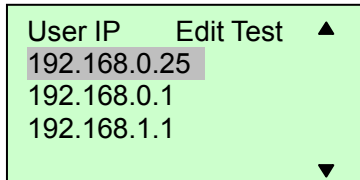

Pic.5.13-3

Press “OK” button, tester will display “Testing”, test result will be displayed after 8 seconds, as Pic.5.13-4 shows:

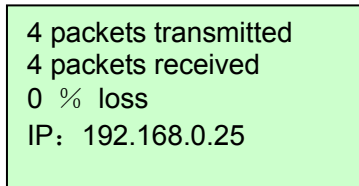

Pic.5.13-4

The address in Pic.5.13-3 is fixed, can not be changed. If you want to enter the IP address, operate through “Up” or “Down” button, the first line tips shows the status of the current site: can be modified or fixed address. Pic.5.13-3 shows that the current site can be modified, press “Left” or

“Right” button on Pic.5.13-3 can revise URL, character modification method see 5.6.2 user name/ password revise.

(1) LAN PING test → LAN ping

PING tests conducted on the LAN, according to data loss rate, judge the connection of the pinging IP address, judge the effectiveness of IP address, to confirm LAN connection (In the absence of computer).

Connect the LAN port and Ethernet port on the hub through network test line (direct line). A cross-test line is needed if connected with the computer.

(2) WAN PING test -> WAN ping

WAN ping operations please see the dial-up test.

Connect the ADSL port to the ADSL line to do the Wan ping test. Ping a website IP to the WAN direction to check WAN connectivity links.

5.14 Charge battery

The tester has a chargeable 2800mAh Li-polymer battery. After starting the tester the battery capacity will be shown in the top right corner of LCD. When the battery symbol is empty please charge it in time, otherwise the tester will display “Switch off after one minute as low voltage”

Charge method: Insert the charger into the charge jacket which is on the top. Then connect charger with 220V AC power socket. If the LED on charger is shining and red it means that the tester is being charged. And charge time is 6~7 hours or so. If the LED turns green from red it means that the battery is fully charged. Please take off the charger.

To ensure to get correct results and protect tester please

don't operate the tester when being charged.

6. Faults and solutions

Faults	Reasons	Solutions	Notes
Nothing displayed after powering on tester.	LCD contract is not proper.	Adjust contrast	Refer to 5.3.
Link LED and PPP LED are in abnormal condition.	Low voltage.	Charge battery.	
PPP dialing failed.	Wrong username or password	Input correct username or password.	
PPP dialing failed with correct username and password	Parameters abnormal on the modem register	Enter into the Sys set, restore factory settings	

7. xDSL test management software

xDSL test management software is the management software of this tester, read real-time data, parameter setting, read and save the record and record analyze functions to help you conveniently and efficiently use this tester.

7.1 Operation environment

We need a PC with port a RS232 connection cable.

Recommended configuration of the PC:

CPU: More than 1G Memory: More than 512Mb

HD: More than 20G Port: One

Operating system: Windows XP

Connecting: Put the DB9 outlet on the RS232 line into the port on the PC, RJ45 insert to the LAN port.

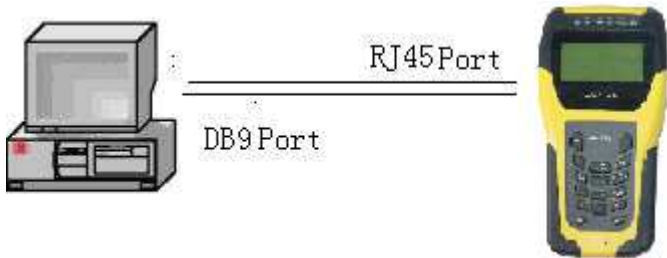

Pic 7.1-1

 **Note: The tester should be in “Data upload” state!**

 Suggested best screen resolution is 1024x768 pixels

7.2 Software function introduction

After connecting with the port, software will display the physical layer data statistics, channel bit chart, VCI VPI, authentication, may revised VCI VPI, authentication information, ping destination address. Instruments will be read in the records and documents stored in the form of local and analysis the records.

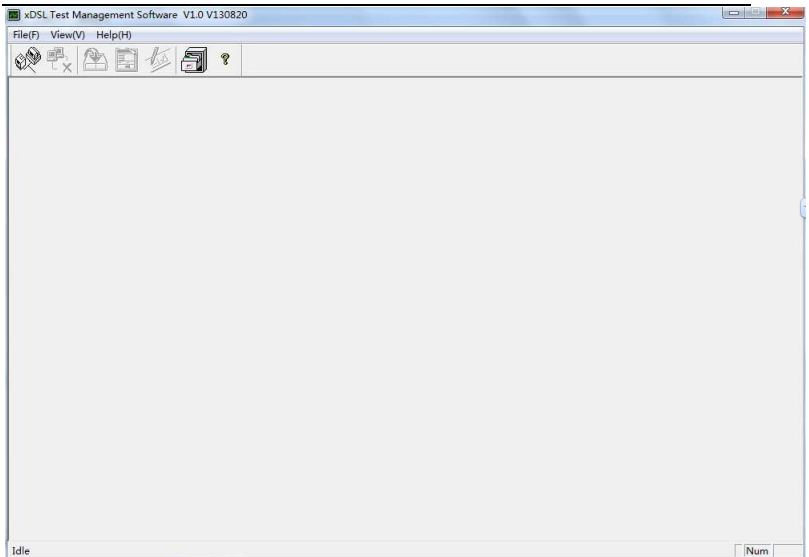

Pic 7.2-1 Software

Connect this tester and Management software.

Connect the tester with PC by port, choose the port you connected, then you can find the chosen port window (Pic7.2-2). Choose the current port and make sure the machine is in the function of data upload, and then click on OK button, the connection is successful.

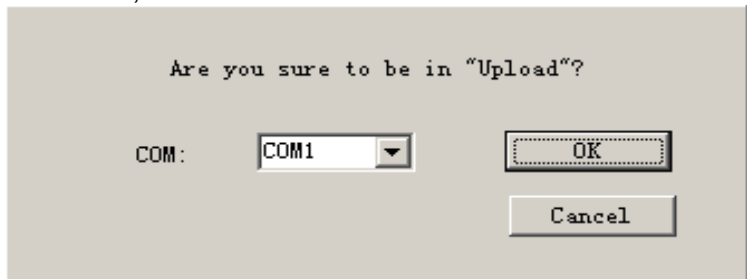

(Pic 7.2-2) Software connection

7.3 Records upload

Choose the file -> read record menu, the “FILE READ” window comes out, then click “Path” and enter the file name (the default for the current date DSL –year –month –date –hour –minute –second, Make sure the file extension is .dsl), click “Read” button to upload records. “Upload success” will display after upload.



Pic 7.3-1 File read

7.4 Real-time data

7.4.1 Physical layer data

Click the icon  or choose menu view-> physical data when the connection is successful, then will popup the physical window(chart 7.4-1),and show the current physical data.



Pic 7.4-1 Physical layer data

7.4.2 Tester setting

After the successful connection between software and this tester. Click the chart  on tool bar or you can choose the menu view->set button when the connection is successful, will popup the set window(Pic 7.4-3) .The set window will display the current data, if any data be changed , click “set” to confirm.

The 'Tester Setting' window contains several configuration sections:

- VPI/VCI:** VPI: 5, VCI: 81
- Ping:** LAN ping: 192.168.0.25, WAN ping: www.hina.com
- User/Password:** User: zhsxnter0e, Pass: zhsxnter
- Encapsulation Mode:** LLC, Other
- Protocol Mode:** PPPoA, PPPoE, Bridge
- xDSL Mode:** annex B, Other

A 'Set' button is located at the bottom right of the window.

Pic 7.4-2 Setting

7.5 Record browse



Click the chart  on tool bar or you can choose the menu view->record view, will popup the record view window (Pic 7.5-1). Click the “Choose patch” button, if the record saved in local patch is available. The data will display when you double click on the file name.

7.5.1 The way to check the file:

1. Input the file No. on the “Pos” of left bottom, click the button” turn”, then you can check the file.
2. Click the bottom buttons to browse files one by one
 “First” go back to the No.1 file
 “Previous” go back to the previous file
 “Next” next file
 “Last” last file.

Path: C:\Users\obj

File Name

- EISL2013-10-17_09-41-56.dsl
- EISL2013-10-17_09-40-24.dsl
- EISL2013-10-17_09-38-55.dsl
- EISL2013-10-17_09-37-29.dsl
- EISL2013-10-17_09-33-34.dsl
- EISL2013-10-17_09-31-54.dsl
- EISL2013-10-17_09-27-36.dsl
- EISL2013-10-17_09-23-59.dsl
- EISL2013-10-17_09-22-33.dsl
- EISL2013-10-17_09-18-35.dsl
- EISL2013-10-17_09-11-08.dsl
- EISL2013-10-17_09-09-34.dsl
- EISL2013-10-17_09-06-23.dsl
- EISL2013-10-17_09-07-14.dsl
- EISL2013-10-17_09-05-00.dsl
- EISL2013-10-17_09-01-52.dsl
- EISL2013-10-17_09-00-26.dsl
- EISL2013-10-16_13-19-26.dsl
- EISL2013-10-16_13-17-55.dsl
- EISL2013-10-16_13-16-28.dsl
- EISL2013-10-16_10-44-18.dsl
- EISL2013-10-16_09-17-26.dsl
- EISL2013-10-16_09-08-06.dsl
- EISL2013-10-15_17-13-57.dsl
- EISL2013-10-15_17-12-12.dsl
- EISL2013-10-15_17-04-21.dsl
- EISL2013-10-15_16-57-47.dsl
- EISL2013-10-15_16-46-35.dsl
- EISL2013-10-15_16-37-11.dsl
- EISL2013-10-15_16-21-04.dsl
- EISL2013-10-12_10-51-08.dsl
- EISL2013-10-12_10-36-42.dsl
- EISL2013-10-11_16-24-28.dsl
- EISL2013-10-11_16-21-46.dsl
- EISL2013-10-11_16-14-27.dsl

Physical Info | Channel Bits Map | SWR | QLN | HLDG

State | Connectando | Standard | ADSL2+ Annex A

	Curr Rate	MaxRate	Atten	Noise	Output
Up	509	588	14.7	25.0	12.4
Down	2560	17980	32.0	34.8	18.2

Band	U0	U1	U2	U3	U4	D1	D2	D3
Atten	N/A	N/A	N/A	N/A	N/A	N/A	N/A	N/A

SWR	N/A	N/A	N/A	N/A	N/A	N/A	N/A	N/A
SWR	N/A	N/A	N/A	N/A	N/A	N/A	N/A	N/A

TxFPower	N/A	N/A	N/A	N/A	N/A	N/A	N/A	N/A
TxFPower	N/A	N/A	N/A	N/A	N/A	N/A	N/A	N/A

Data statistics

	IMP	MBER	OCD	LCD	FEC	CRC
Up	1.50	0	0	0	0	0
Down	5.00	0	0	0	0	0

Record Operation

First Last Curr Pos 1 Turn Print

Previous Next

Change Directory

Pic 7.5-1Record browse

7.5.2 Data print out

If the data need to be printed. Click on the print button you can choose the request print area in the print window (Pic 7.5-2).

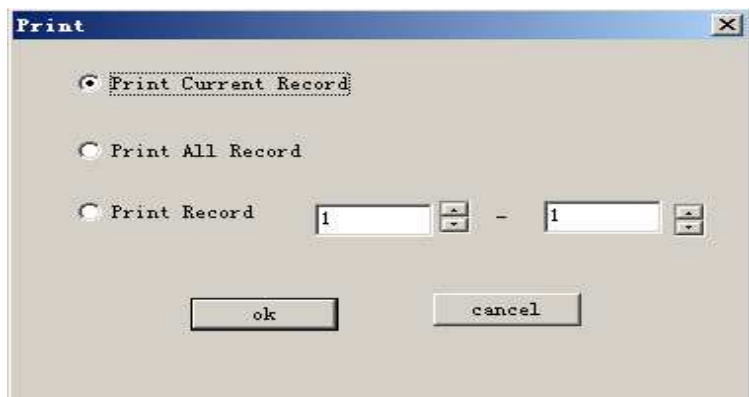

Pic 7.5-2 Print set